

**DESIGN + ENGINEERING  
AMERICAN STANDARD**

FF1-CN521K00476599/A0

[www.americanstandard-apac.com](http://www.americanstandard-apac.com)

*American Standard*

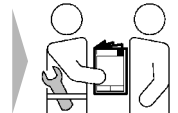
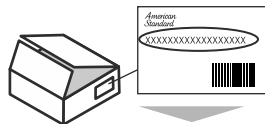
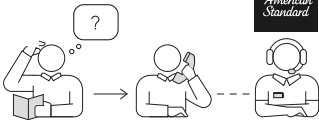
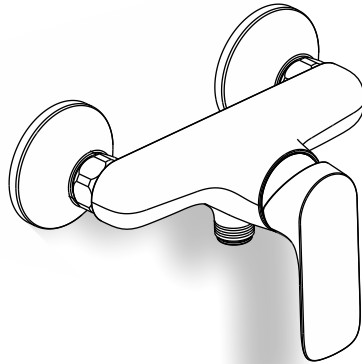
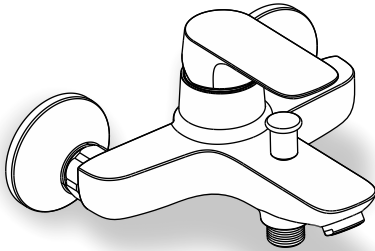
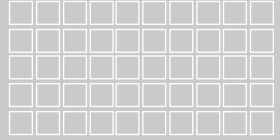

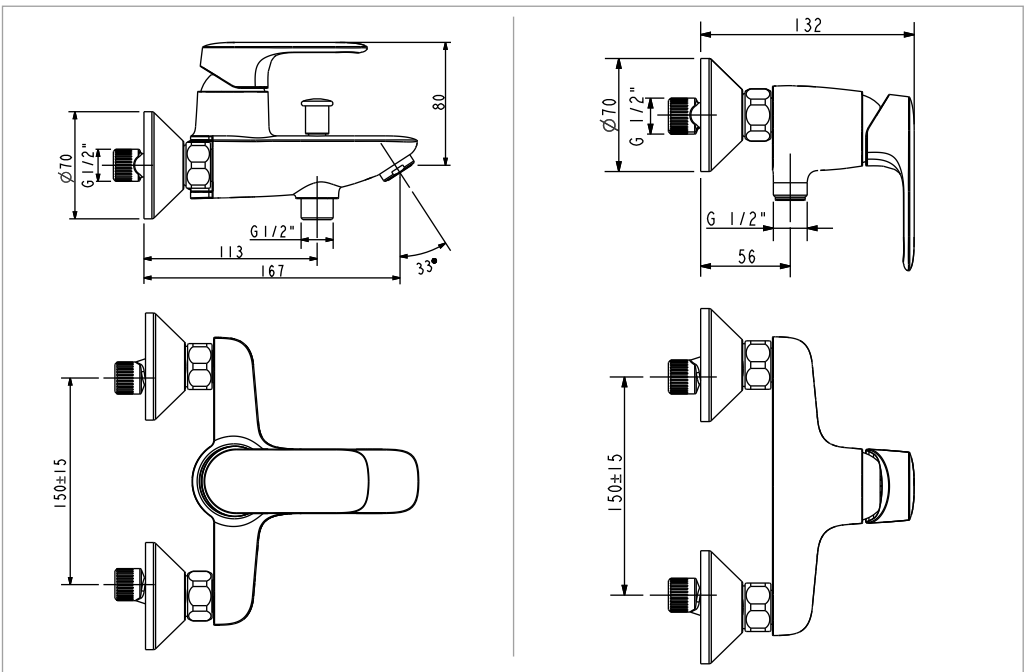
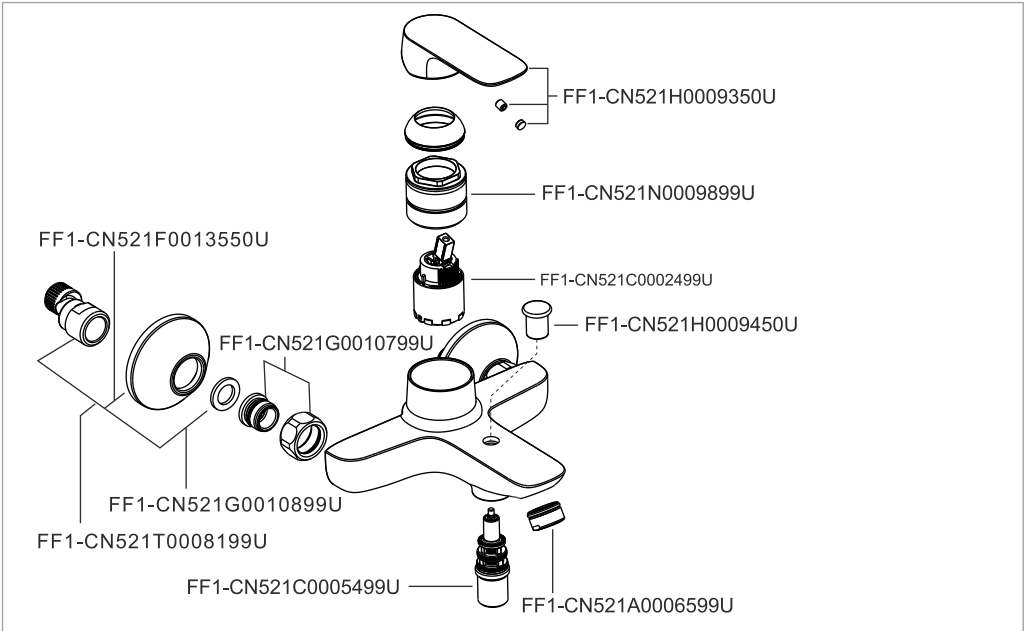

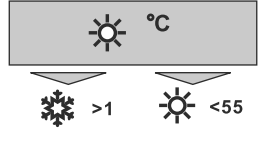
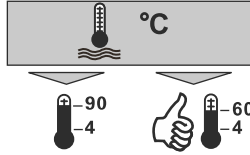
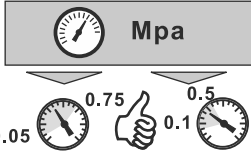

1

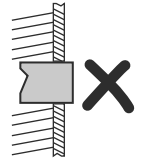
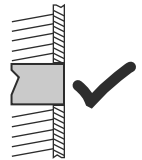
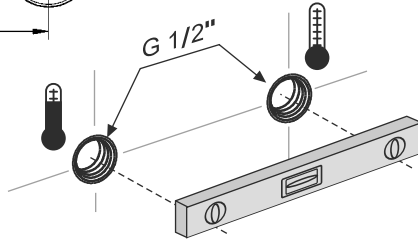
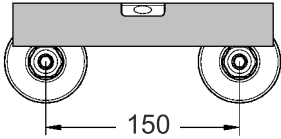

2

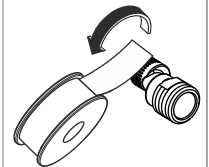
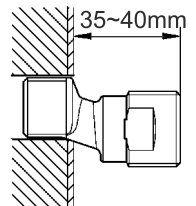
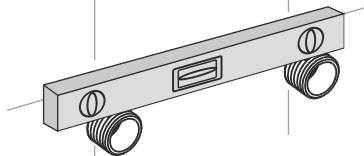
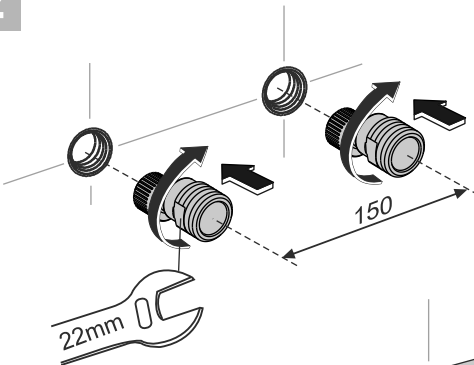



1

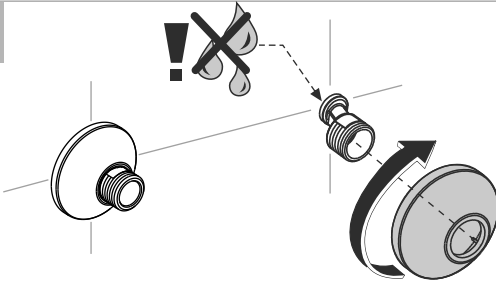

2

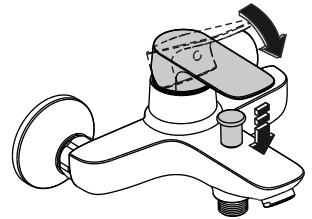
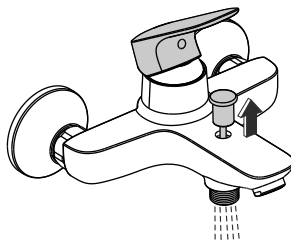
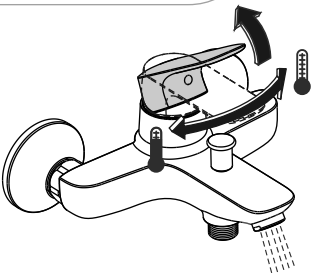
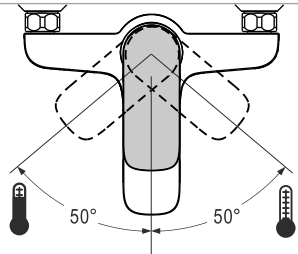
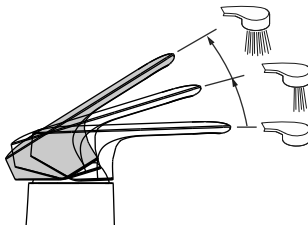
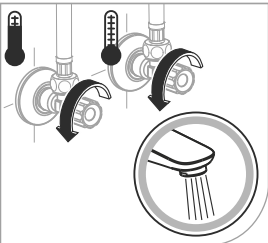
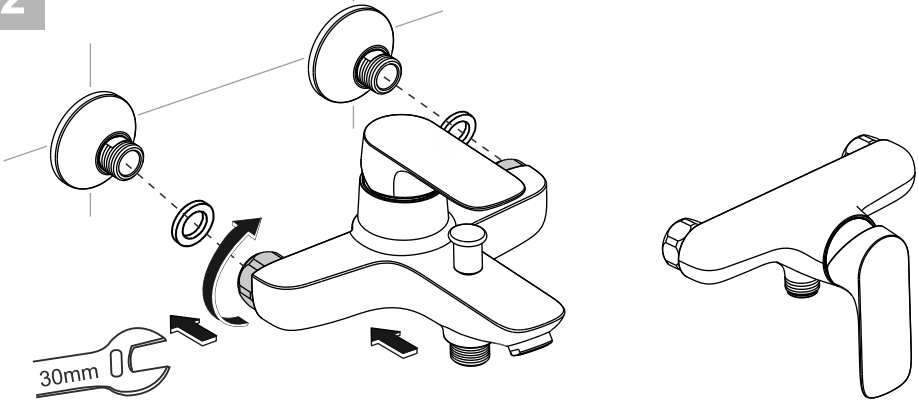

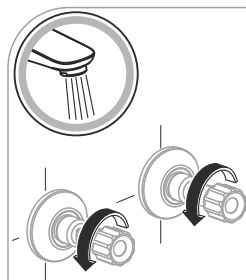
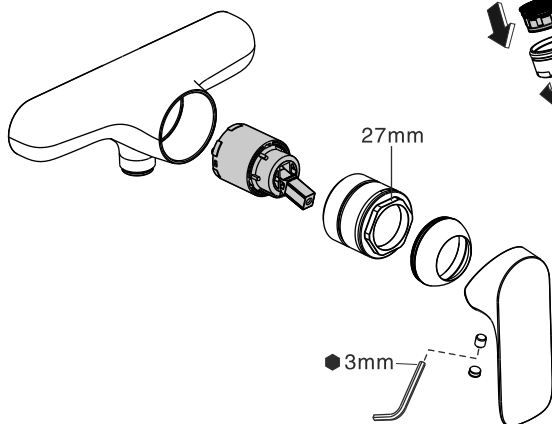
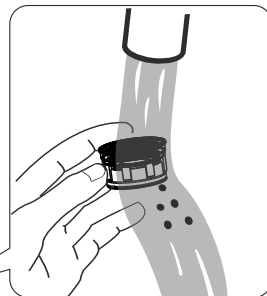
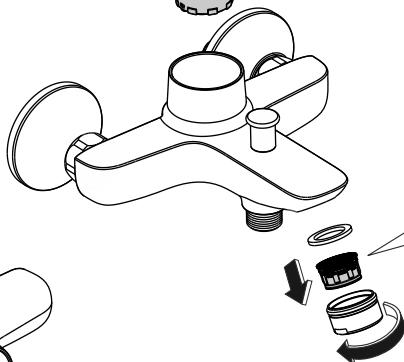
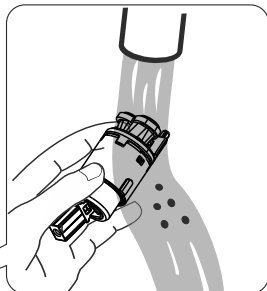
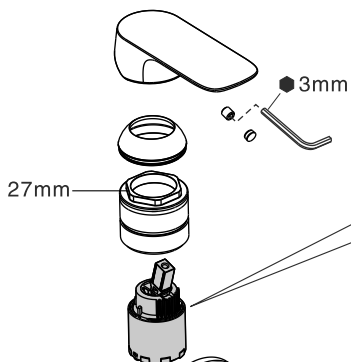
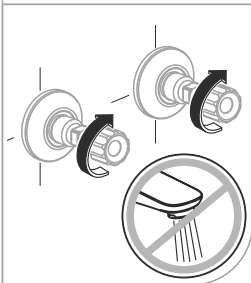
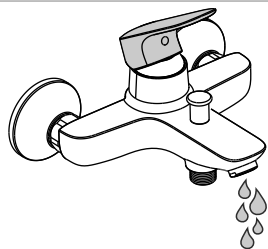



## CN

- \* 安装须由专业人员进行。
- \* 使用水源: 市政饮用水。(请确保水源清洁, 低质量的水会导致滤芯或内部组件堵塞, 影响产品性能。
- \* 进行清洁时, 请勿使用研磨海绵、擦洗剂、有机溶剂或酸性清洁剂、水垢去除剂、食用醋或含有醋酸的清洁剂。
- \* 本体组已由工厂检验即调试至最佳工作状态, 请勿自行拆装。
- \* 请保管好说明书和特配工具, 以便作维护使用。
- \* 如需维修或有其他故障不能排除时, 请专业人员来解决或打售后服务电话。

## EN

- \* Product should be installed by a certified plumber.
- \* Ensure clean water source – poor water quality can cause cartridge and internal components to clog, resulting in poor water flow and/or product failure.
- \* Do not use abrasive sponges, scouring agents, organic solvents or acidic cleaners, limescale removers, household vinegar or cleaners containing acetic acid on product.
- \* Product has been fully assembled and inspected in the factory, there is no need to disassemble it/ any components during installation.
- \* Please retain this installation manual and any accompanying tools for maintenance purposes.
- \* Please contact our local after-sales service should the product malfunction/ require repairs.

## TH

- \* ควรติดตั้งสินค้าโดยผู้เชี่ยวชาญ
- \* ควรตรวจสอบความสะอาดของน้ำในการใช้งาน เพื่อป้องกันการตกตะกอนอันเป็นสาเหตุของการอุดตัน และ ประสิทธิภาพการไหลของน้ำ
- \* ควรใช้ฟองน้ำที่มีความนุ่มทำความสะอาด หลีกเลี่ยงการใช้ด้ายอุปกรณ์ที่มีความหยาบ และ น้ำยาทำความสะอาดที่มีฤทธิ์รุนแรง
- \* ห้ามดัดแปลงสินค้า เนื่องจากสินค้าถูกประกอบมาเพื่อพร้อมติดตั้งและใช้งาน การแยกชิ้นส่วน หรือ ดัดแปลง อาจส่งผลกระทบต่อคุณภาพ และ ประสิทธิภาพในการใช้งาน
- \* โปรดศึกษาและปฏิบัติตามคู่มือเพื่อการดูแลรักษาอย่างถูกต้อง
- \* ท่านสามารถติดต่อบริการหลังการขาย เพื่อรับคำแนะนำในการแก้ปัญหาเบื้องต้นด้วยตัวท่านเอง หรือ ขอนัดเพื่อรับบริการซ่อม

## ID

- \* Produk harus dipasang oleh plumber tersertifikasi.
- \* Pastikan sumber air yang bersih – buruknya kualitas air dapat mengakibatkan cartridge dan komponen didalamnya tersumbat, mengakibatkan aliran air yang kecil dan/atau kegagalan produk.
- \* Jangan gunakan spons kasar, zat pembersih, cairan organik atau pembersih bersifat asam, pembersih kerak, cuka dapur atau pembersih yang mengandung asam asetat pada produk.
- \* Produk telah dirakit dan diperiksa seutuhnya di pabrik, tidak perlu untuk membongkar produk/komponen apapun selama proses pemasangan.
- \* Tolong simpan petunjuk pemasangan ini dan peralatan bawaan untuk keperluan perawatan.
- \* Silahkan hubungi layanan purnajual kami jika ditemukan produk tidak berfungsi/ membutuhkan perbaikan.

## VN

- \* Sản phẩm nên được lắp đặt bởi một người có kinh nghiệm.
- \* Đảm bảo nguồn nước sạch. Chất lượng nước bẩn có thể làm cho van điều khiển lưu lượng và các linh kiện bên trong bị nghẹt, dẫn đến lưu lượng yếu hoặc gây nên lỗi cho sản phẩm.
- \* Không sử dụng miếng bọt biển mài mòn, chất tẩy, dung môi hữu cơ, hoặc chất tẩy tính axit, chất tẩy rửa cặn ri, giấm hoặc chất tẩy rửa có chứa axit acetic để vệ sinh.
- \* Thân vòi đã được kiểm tra và cam kết bởi nhà máy sản xuất ở điều kiện làm việc tốt nhất. Vui lòng không tháo rời sản phẩm.
- \* Vui lòng lưu giữ hướng dẫn sử dụng và các công cụ chuyên dụng để bảo trì sản phẩm.
- \* Nếu sản phẩm cần được sửa chữa hoặc bị trục trặc gì, bạn có thể gọi thợ tới giải quyết hoặc gọi cho phía dịch vụ sau bán hàng.