

Kl_üger

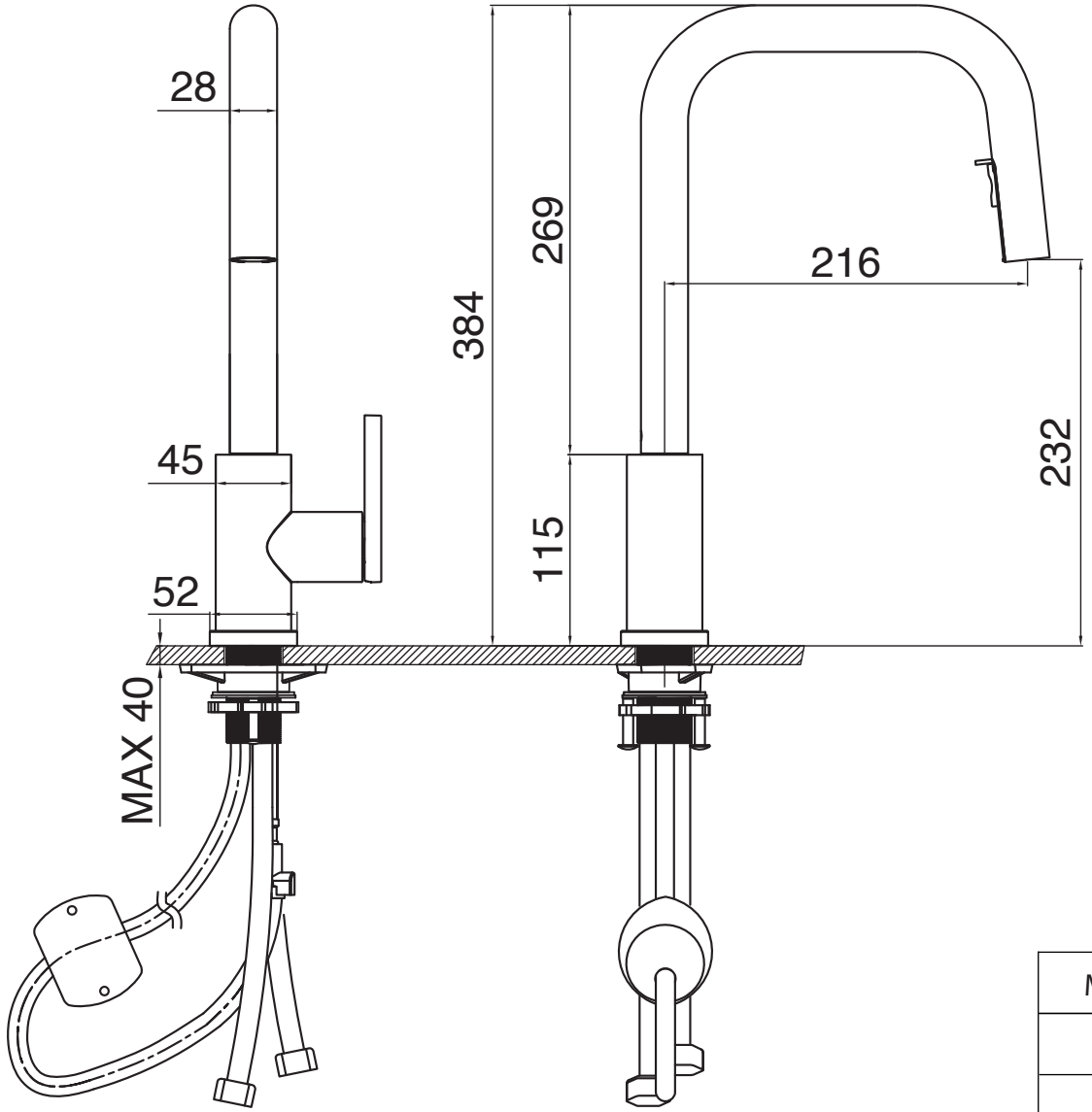

MMC INTERNATIONAL COMPANY LIMITED	
MODEL	KLF0015C
UNIT	MM
MATERIAL	STAINLESS STEEL